

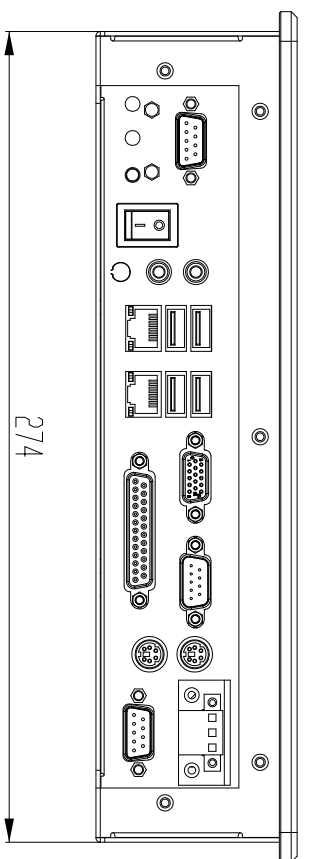

| | | | | |
|------|------|--------------------|------|----------|
| MARK | DATE | UPDATE DESCRIPTION | SIGN | APPROVER |
| △ | | | | |

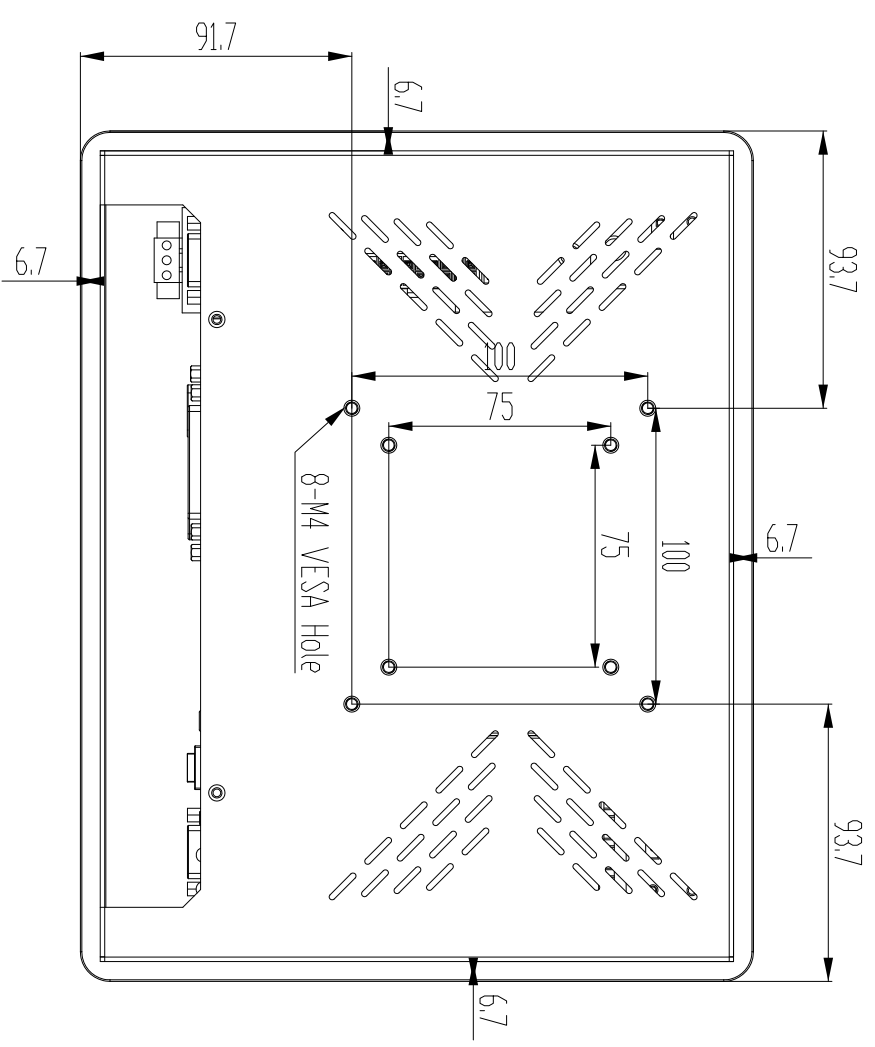
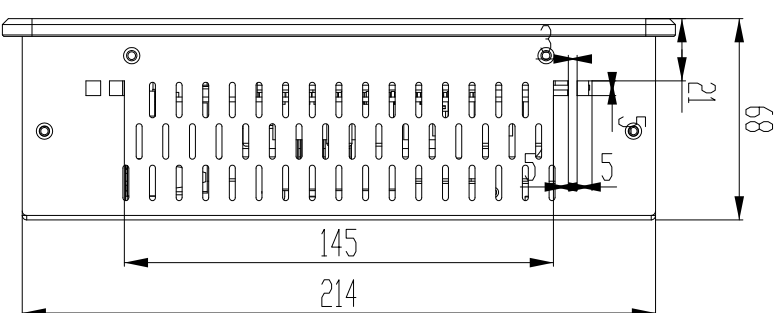
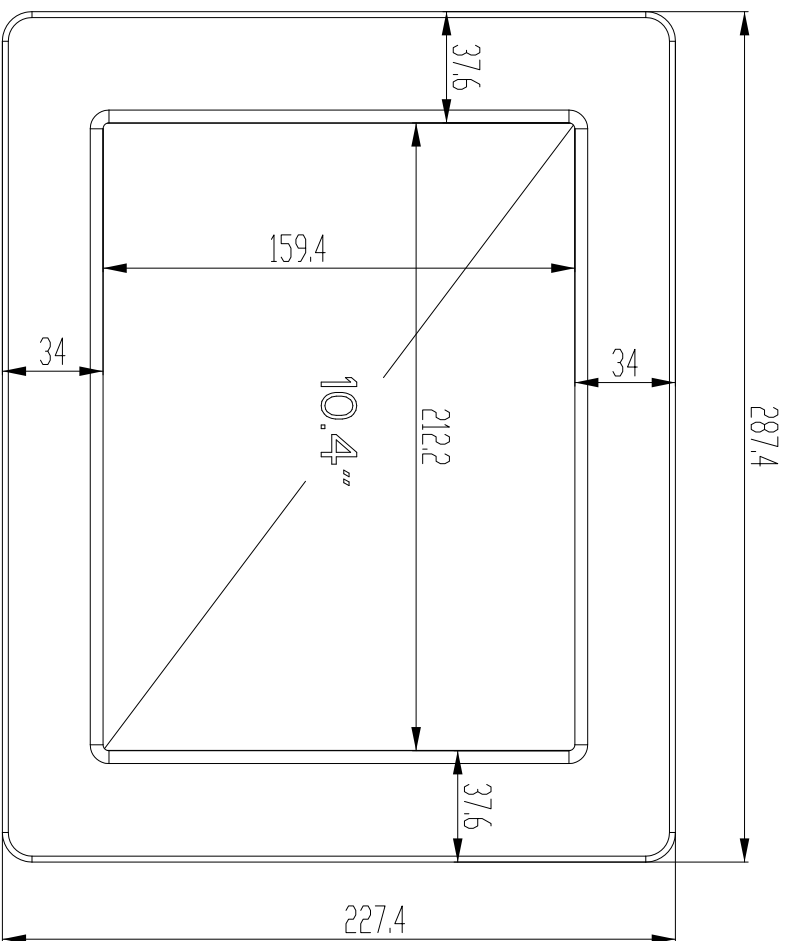
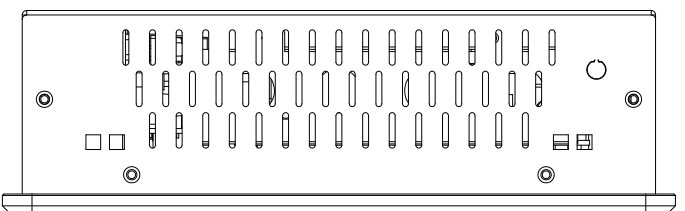
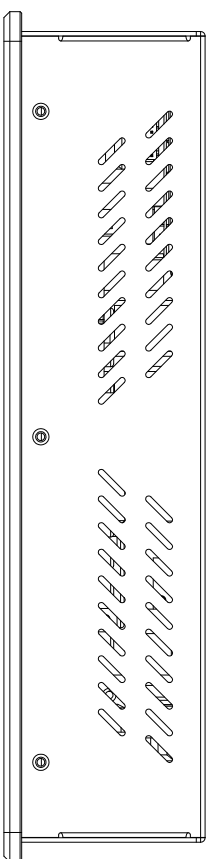

CUT OUT DIMENSION(276x216mm) UNIT:mm

* Note: this is a simplified drawing and some components are not marked in detail.
Please contact our sales representative if you need further product information.

| | | | | | | | |
|--|--|-----------|-----------|-------------|-------------------|---------------|--------|
|  www.anxinpc.com | | FINISHING | | PART NO. | | Ver. | A0 |
| | | MATERIAL | | MOLD NO. | IPC-10DN | Qty | 1 |
| APPROVED | | CHECKED | | TITLE | | IPC-10DN-3D3V | |
| DESIGNED | | DATE | 01-Mar-13 | DRAWING NO. | IPC-10DN-3D3V.DWG | SCALE | 0.25 |
| 3RD ANGLES | | UNIT : mm | ±0.1 | SIZE | A3 | SHEET: | 1 OF 1 |
| ANGLE TDL : | | ±0.15 | 30 | | | | |
| | | ±0.2 | < 120 | | | | |
| | | ±0.25 | < 315 | | | | |
| | | ±0.5° | 315 | | | | |

