

|      |      |                    |      |          |
|------|------|--------------------|------|----------|
| MARK | DATE | UPDATE DESCRIPTION | SIGN | APPROVER |
| △    |      |                    |      |          |

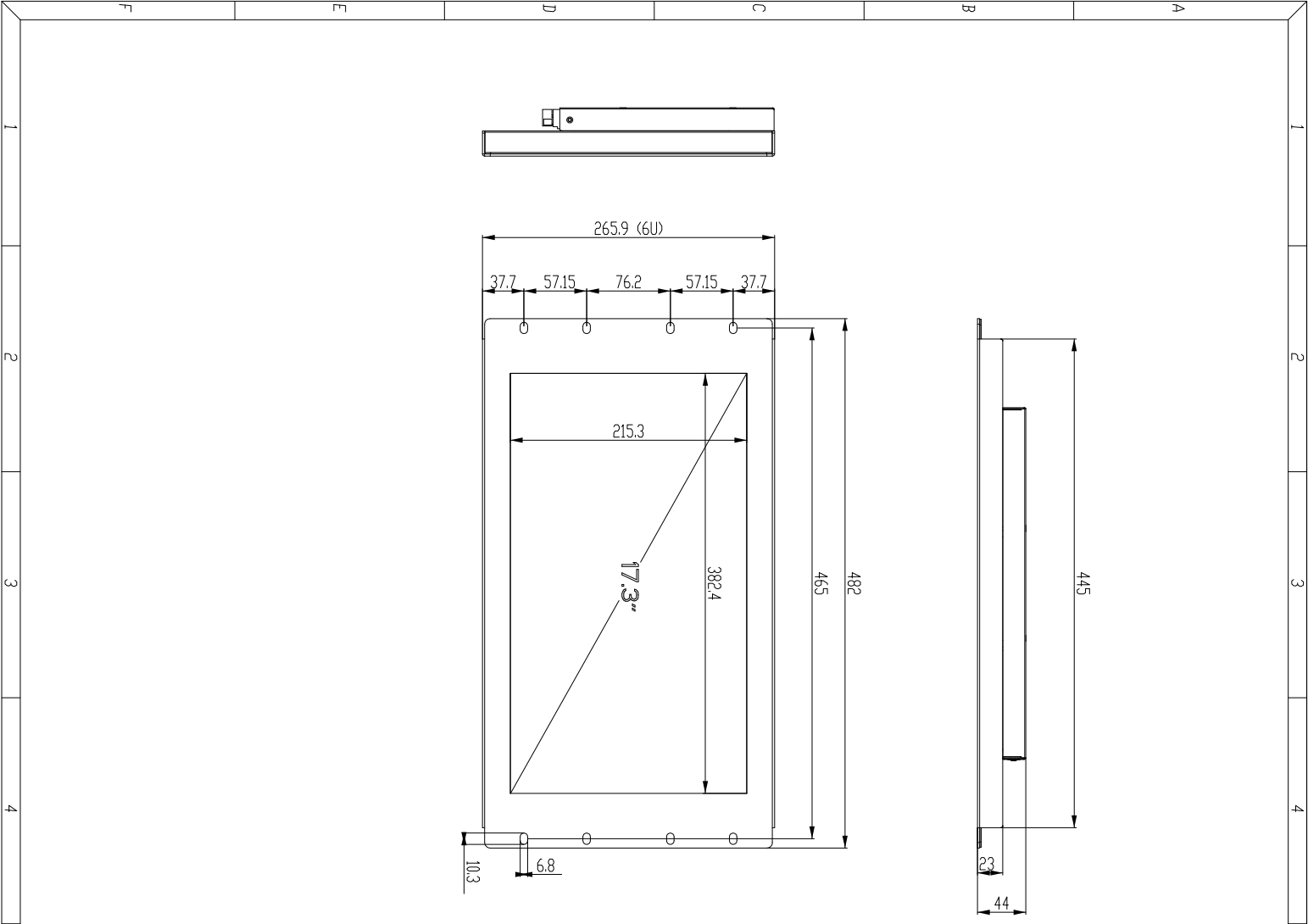
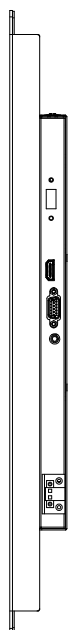
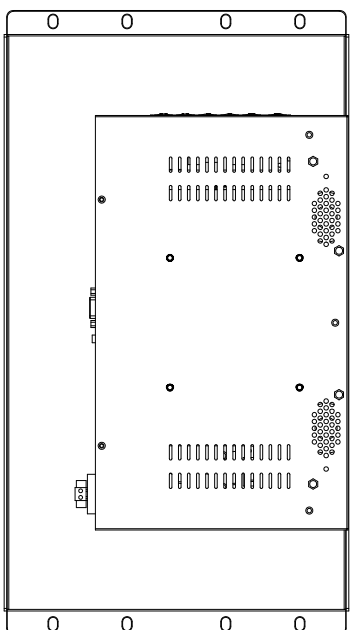
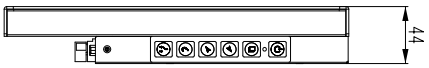
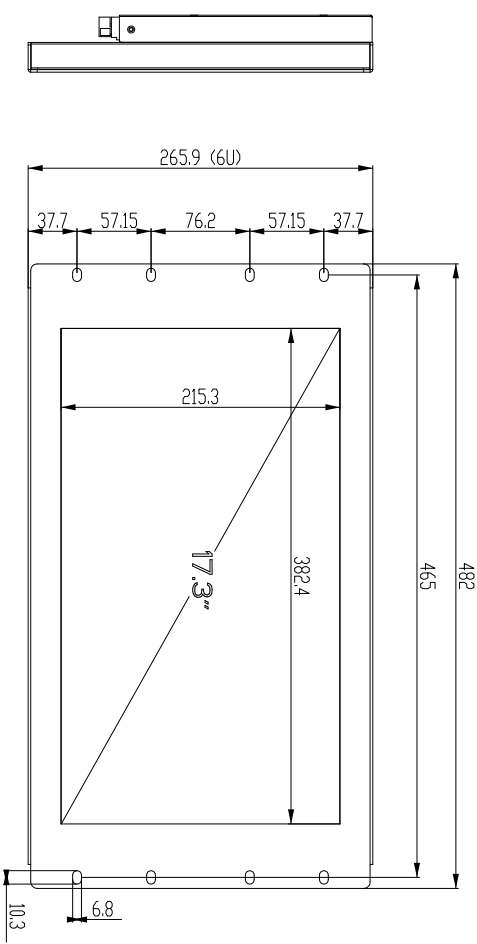
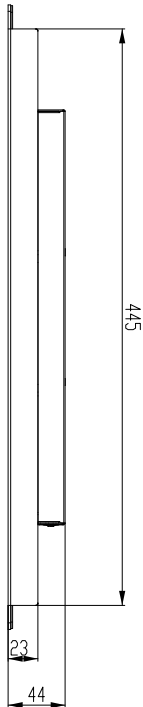
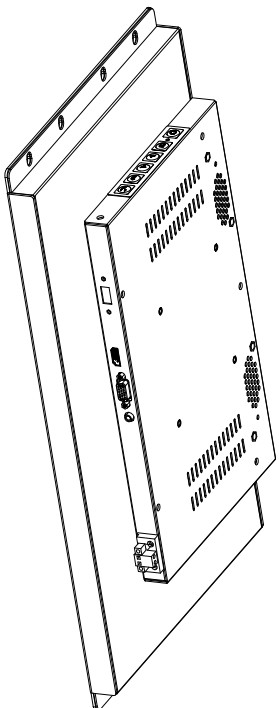

www.anxinpc.com

|           |          |           |     |
|-----------|----------|-----------|-----|
| FINISHING | PART NO. | Ver.      | A0  |
| MATERIAL  | MOUD NO. | RCIM-173W | Qty |
| APPROVED  |          |           | 1   |

|             |     |       |            |           |             |               |
|-------------|-----|-------|------------|-----------|-------------|---------------|
| TOL         | 30  | ±0.1  | UNIT : mm  | CHECKED   | TITLE       | RCIM-173W     |
|             | 120 | ±0.15 | 3RD ANGLES | DESIGNED  | DRAWING NO. | RCIM-173W.DWG |
|             | 315 | ±0.2  |            | DATE      | SIZE        | A3            |
| ANGLE TOL : |     | ±0.25 |            | 18-Mar-20 | SCALE       | 0.25          |
|             |     | ±0.5° |            |           | SHEET:      | 1 OF 1        |

30 < 120 < 315 < ANGLE TOL : ±0.1 ±0.15 ±0.2 ±0.25 ±0.5°